

TOP VIEW
正视图

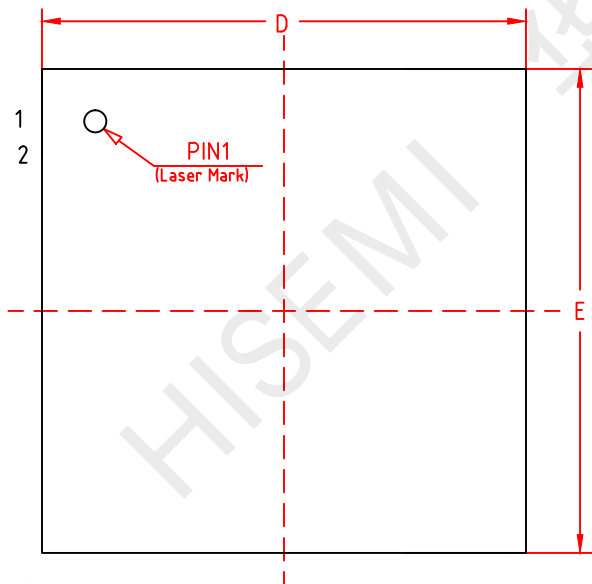

SIDE VIEW
侧视图

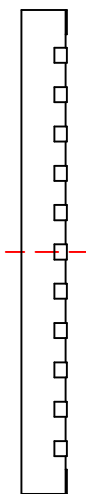

BOTTOM VIEW
背视图

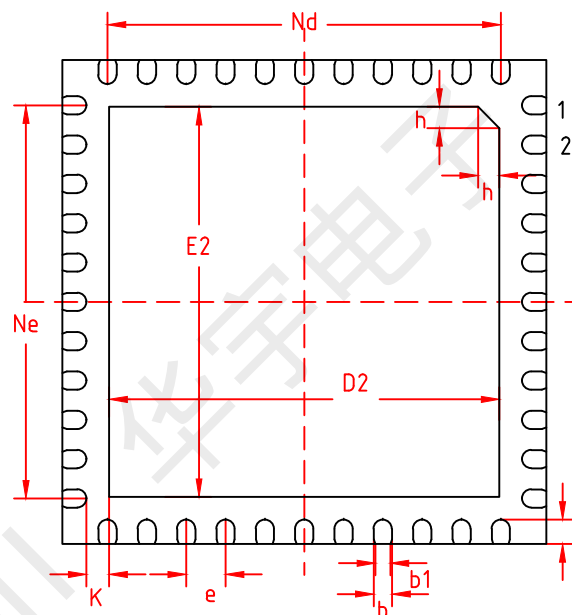

SIDE VIEW
侧视图

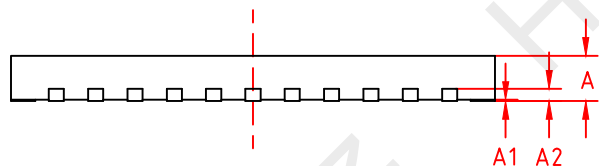

机械尺寸/mm

字符 SYMBOL	最小值 MIN	典型值 NOMINAL	最大值 MAX
A	0.70	0.75	0.80
A1	-	0.02	0.05
A2	0.203 REF		
b	0.25	0.30	0.35
b1	0.20	0.25	0.30
D	7.90	8.00	8.10
D2	6.35	6.45	6.55
E	7.90	8.00	8.10
E2	6.35	6.45	6.55
e	0.65 BSC		
K	0.325	0.375	0.425
L	0.35	0.40	0.45
h	0.30	0.35	0.40
Ne	6.50 BSC		
Nd	6.50 BSC		

 池州华宇电子科技股份有限公司 CHI ZHOU HISEMI ELECTRONICS TECHNOLOGY CO.,LTD				制图: Draw	李家通 2022.03.30
图号 Drawing NO.	HY-POD-QFN4408001			制图核查: Drawing review	
Title 产品外形图	PACKAGE OUTLINE DIMENSIONS QFN44L (8×8×0.75-P0.65)			审核: Checker	
幅图 size	页数 page	单位 unit	比例 scale	视图 view	核准: Approved
A4	1	mm	1:1	